

AlGaAs/GaAs T-1 3/4 PACKAGE INFRARED EMITTING DIODE

MIE-554A4

Description

The MIE-554A4 is an infrared emitting diode utilizing GaAs with AlGaAs window coating chip technology. It is molded in water clear plastic package.

Features

- High radiant power and high radiant intensity
- Suitable for DC and high pulse current operation
- Standard T-1 3/4 ($\phi 5\text{mm}$) package
- Peak wavelength $\lambda_p = 940\text{ nm}$
- Good spectral matching to si-photodetector
- Radiant angle : 50°

Package Dimensions

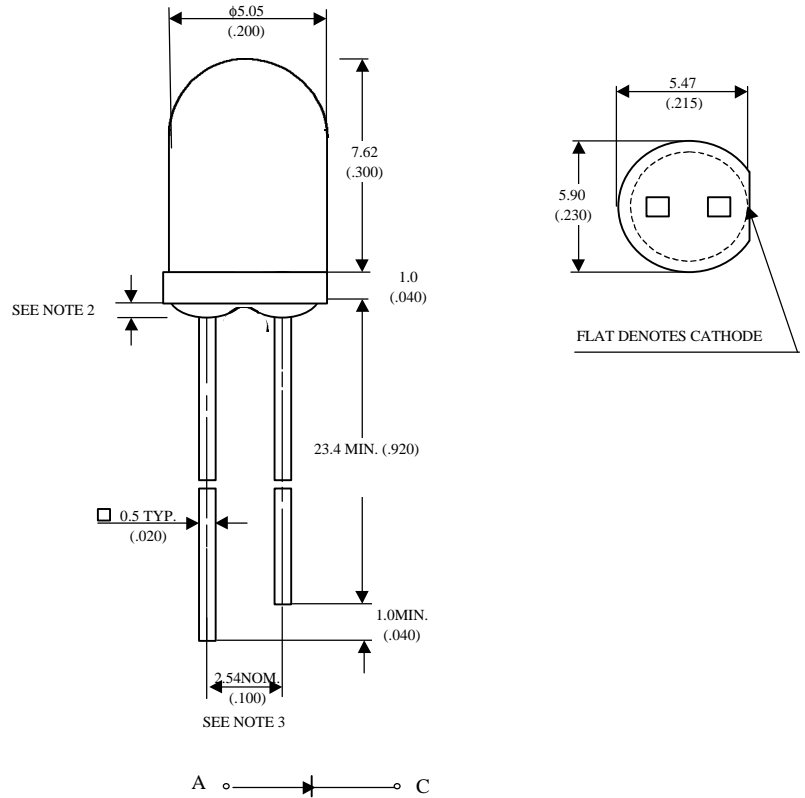

Notes :

1. Tolerance is $\pm 0.25\text{ mm}$ (.010") unless otherwise noted.
2. Protruded resin under flange is 1.5 mm (.059") max.
3. Lead spacing is measured where the leads emerge from the package.

Absolute Maximum Ratings

@ $T_A = 25^\circ\text{C}$

Parameter	Maximum Rating	Unit
Power Dissipation	120	mW
Peak Forward Current(300pps,10 μ s pulse)	1	A
Continuous Forward Current	100	mA
Reverse Voltage	5	V
Operating Temperature Range	-55 $^\circ\text{C}$ to +100 $^\circ\text{C}$	
Storage Temperature Range	-55 $^\circ\text{C}$ to +100 $^\circ\text{C}$	
Lead Soldering Temperature	260 $^\circ\text{C}$ for 5 seconds	

Optical-Electrical Characteristics

@ T_A=25°C

Parameter	Test Conditions	Symbol	Min.	Typ .	Max.	Unit
Radiant Intensity	I _F =20mA	I _e	0.5	1.5		mW/sr
Forward Voltage	I _F =50mA	V _F		1.30	1.50	V
Reverse Current	V _R =5V	I _R			100	μA
Peak Wavelength	I _F =20mA	λ _p		940		nm
Spectral Bandwidth	I _F =20mA	Δλ		50		nm
View Angle	I _F =20mA	2 θ _{1/2}		50		deg .

Typical Optical-Electrical Characteristic Curves

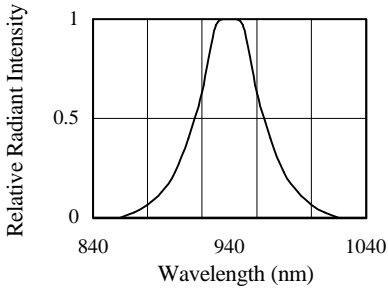

FIG.1 SPECTRAL DISTRIBUTION

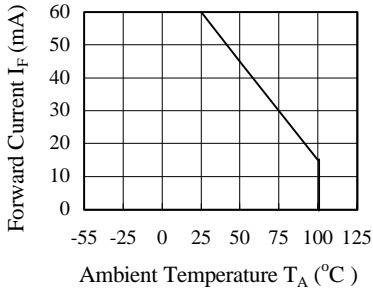

FIG.2 FORWARD CURRENT VS. AMBIENT TEMPERATURE

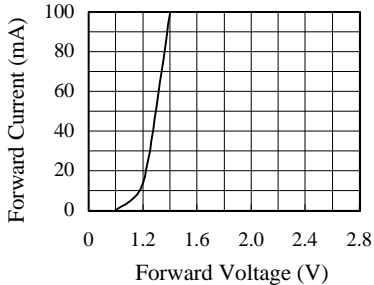

FIG.3 FORWARD CURRENT VS. FORWARD VOLTAGE

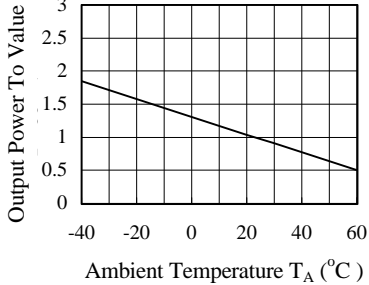

FIG.4 RELATIVE RADIANT INTENSITY VS. AMBIENT TEMPERATURE

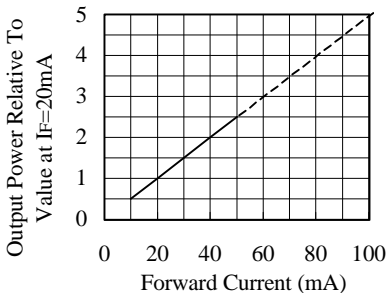

FIG.4 RELATIVE RADIANT INTENSITY VS. FORWARD CURRENT

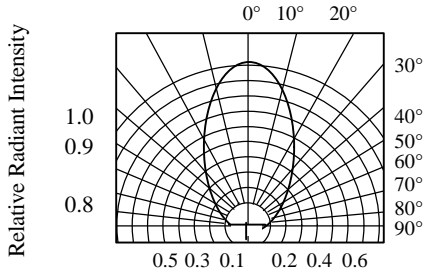

FIG.6 RADIATION DIAGRAM